

Digital Home Cinema Amplifier

DSP-Z9

Yamaha introduces a new benchmark for amplifier performance: the DSP-Z9.

This flagship model goes beyond the capabilities of previous high-end Yamaha models with High Definition CINEMA DSP technology, the ability to automatically optimize the sound for the listening room, superior audio and video quality, and the operating ease that Yamaha is famous for. The high end just moved up a step.



The DSP-Z9 not only delivers the highest level of sound quality — it automatically optimizes the sound for the room!

If this amplifier doesn't have it, you don't need it! A huge array of features and connections make the DSP-Z9 the world's most versatile and enjoyable amplifier.

The DSP-Z9 is an Audiophile's Delight

The DSP-Z9 has all the features a dedicated audiophile could want, and then some! Naturally, you get all the benefits of Yamaha's industry-leading CINEMA DSP technology, available in a broad selection of 55 surround programmes with 79 variations. SILENT CINEMA allows surround sound to be heard through headphones. The all-new YPAO (Yamaha Parametric Room Acoustic Optimizer) functions as a high-end parametric equalizer to automatically analyze the room acoustics and optimize the sound output to match. A wide range of audio and video functions are provided, and the user-friendly GUI display offers an extensive choice of useful menus.

- 9.1-channel, 2,280W powerful surround sound (300W x 7 + 90W x 2 [DIN])
- Digital ToP-ART (Total Purity Audio Reproduction Technology) and High Current Amplification
- Pure Direct mode for high quality 2-channel sound reproduction
- i.LINK digital audio interface for Super Audio CD/DVD-Audio
- Heavy-duty, rigid chassis symmetric construction with separate chambers and finest parts used throughout
- High-Definition* CINEMA DSP by powerful 32-bit Yamaha LSIs (YSS-930 x 4)
* Double the speed and triple the density compared to previous processing system
- Compatibility with latest movie sound formats including Dolby Digital EX, Dolby Pro Logic IIx, DTS-ES Discrete 6.1, DTS Neo:6 and DTS 96/24
- THX Ultra2 Processing
- 55 surround programmes (79 variations) with SILENT CINEMA and Night Listening mode
- 192 kHz/24-bit D/A converter for all channels
- Digital component video up conversion
- Progressive Scan Output, Noise Shaped Video, DCDi, TrueLife Enhancer
- YPAO (Yamaha Parametric Room Acoustic Optimizer)
- On-Screen Display with GUI (Graphical User Interface)
- Custom installation compatibility with RS-232C and remote control IR code

DSP-Z9

Digital Home Cinema Amplifier

Black finish available in some areas.



DIGITAL ToP·ART

Total Purity
Audio Reproduction Technology

From digital input, through digital processing,
to amplification, maximum signal quality is maintained
every step of the way.

Digital ToP-ART (Total Purity Audio Reproduction Technology) is the name Yamaha has given to a design philosophy whose goal is to maximize digital quality while minimizing analogue circuitry. The culmination of the best digital engineering and design possible today, it brings together several key elements to create the best-sounding, easiest-to-use A/V components available. In the DSP-Z9, Digital ToP-ART can be divided into three categories.

- 1** High Performance Digital Circuitry with Burr-Brown 24-bit DACs for all 11 output channels and an Accurate Touch Volume Control with 96.5dB range.
- 2** High-Definition CINEMA DSP Circuitry with the new powerful 32-bit floating point quantization LSIs (YSS-930 x 4).
- 3** High Current Amplification with low-impedance design, superior toroidal transformer, gigantic heat sinks and many other advantages.

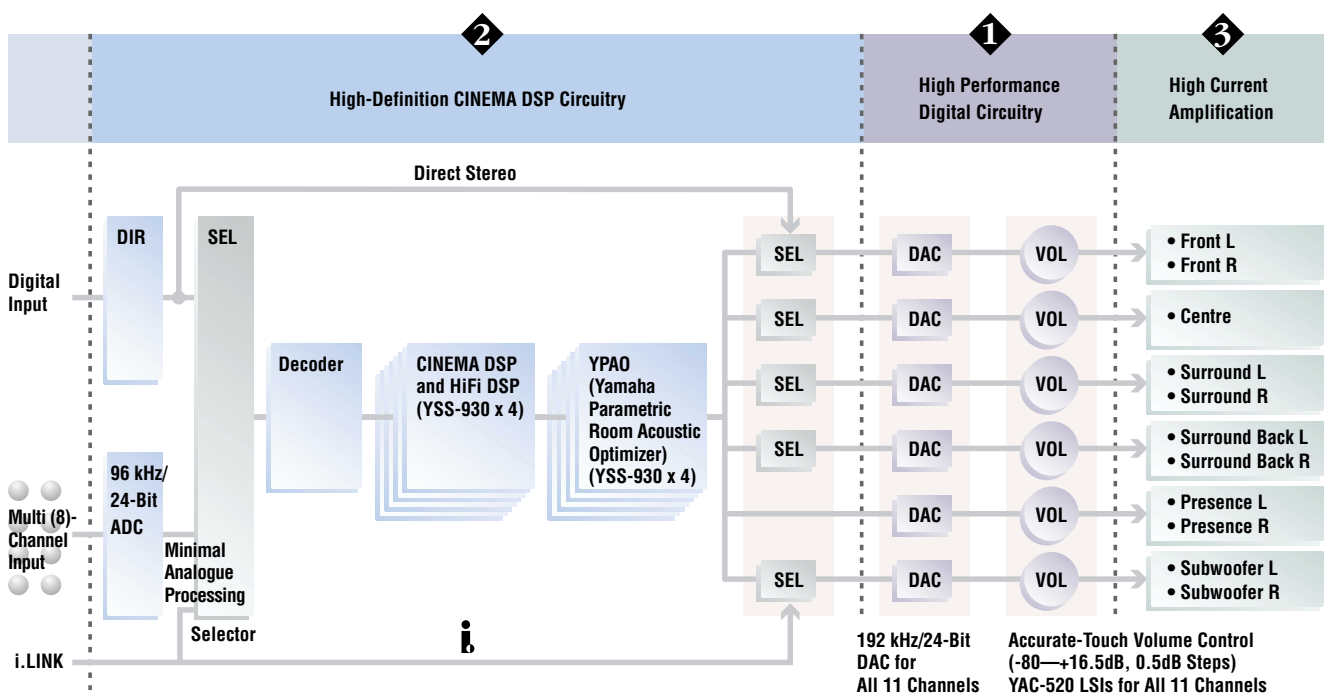

The DSP-Z9 not only delivers the highest level of sound quality



High Performance Digital Circuitry

The DSP-Z9 employs a wide array of sophisticated technology, beginning with Burr-Brown 192-kHz/24-bit digital-to-analogue converters for all 11 channels with DSD (Direct Stream Digital) compatibility. An Accurate-Touch Volume Control is also used for all channels (Yamaha YAC520 LSIs). The digital bass/treble tone controls have turnover frequencies for main L/R and centre channels. 8-channel analogue input signals are processed by 96kHz A/D conversion for high sound quality. All circuitry is on a 4-layer processing board with fully shielded cabinet for reduced digital interference. The DSP-Z9 also offers i.LINK (IEEE1394) compatibility.

Choice of Signal Paths for Higher Sound Quality

The DSP-Z9 gives you a choice of five specialized signal paths, ensuring that you can obtain the purest signal quality possible. Pure

Direct provides the shortest possible signal path for two-channel or multi-channel analog inputs, with no signal processing and no display. Straight outputs the original analog or digital signal without any post-processing. Direct Stereo provides a direct connection for stereo input, with a

dimmed display. 2-Channel Stereo processes the multi-channel signal and outputs it via two channels, for those with a two-speaker system. And i.LINK provides a digital connection for DVD-Audio Linear PCM, Super Audio CD DSD (Direct Stream Digital) and other high quality audio sources.

DSP-Z9 Front Channel Signal Flow

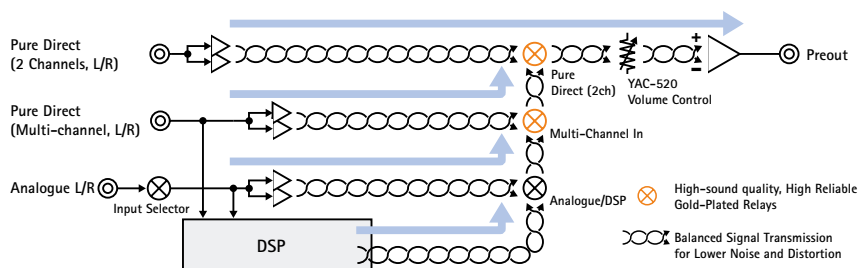

DSP-Z9 Operation Difference

	Pure Direct	Straight	Direct Stereo
Operation	Front Panel & Remote	Front Panel & Remote	Programme
Source	2-Ch Analogue (Direct Input)/ Multi-Ch Analogue	Analogue & Digital	Analogue & Digital (PCM/DSD)
A/D Conversion	—	Yes	No
Decoder	—	Yes	No
Post Processing	—	No	No (Bypass)
YPAO/Sp Configuration	—	Yes	No (Bypass)
YPAO/Tone Control	—	Yes	No
YPAO/Speaker Level	No	Yes	No
FL Display	Off	Yes	Dimmer

3 Front Operational Modes

Pure Direct: For pure analog audio enjoyment.

This mode provides the shortest signal path and eliminates as many control, processing and display functions as possible. It accepts Super Audio CD and DVD-Audio inputs.

Straight: For original channel audio enjoyment without post-processing.

This mode accepts both analog and digital sources, providing decoding but not post-processing. It can

handle two-channel and multi-channel sources, and the YPAO speaker configuration, tone control and speaker level functions are applicable.

Direct Stereo: For direct two-channel enjoyment.

This mode accepts two-channel analog and digital sources, bypassing the DSP and other processing circuits. Note: Mode priority is in the above order.

Burr-Brown 192 kHz/24 Bit PCM1792 DACs

The PCM1792 is a high-performance, precision 24-bit DAC with ultra-low distortion of only 0.0004% (THD + N) and S/N ratio of 129dB. It offers superior low level linearity, with excellent full-scale performance under varying operating conditions. Its major benefit is performing accurate sound field reproduction for high quality multi-channel reproduction such as Dolby Digital and DTS.

— it automatically optimizes the sound for the room!

DIGITAL
TOP·ART 2

High-Definition CINEMA DSP Circuitry

The DSP-Z9 has six times greater DSP capacity than previous models, thanks to an increase from 48kHz A/D converters to 96kHz/24-bit types that can accept 96kHz signals for direct digital conversion and processing. Higher density processing enables approximately triple the amount of early reflection data to be handled, for significantly richer surround sound performance. The DSP-Z9 also employs 192kHz/24-bit D/A conversion and DSP processing and Yamaha's 32-Bit Floating-Point Quantization System LSIs (YSS-930 x

4) for high precision decoding of Dolby Digital, DTS Digital Surround, DTS 96/24, DTS-ES Discrete 6.1, DTS-ES Matrix 6.1, DTS Neo:6



Yamaha's Exclusive YSS-930 32-Bit Floating Point Quantization LSI

and Dolby Pro Logic IIx formats. There are 55 surround programmes available, with 79 variations, including Quad-Field CINEMA DSP programmes for 6.1-Channel Digital Surround. SILENT CINEMA for surround sound through headphones

Accurate Touch Volume Control

No one expects more from a volume control than up and down — except

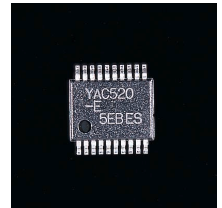

Digitally Regulated Volume Control Device (Yamaha Original YAC-520 LSI)

Yamaha. We decided that controlling the volume could be made both easier and more accurate, and the result is the Accurate Touch Volume Control. It lets you make delicate adjustments within a narrow range, yet enables you to move to very high or low levels more quickly. Its extreme accuracy, with negative gang error of less than 0.5dB, due to a high-signal-resolution analog design in conjunction with an ultra-precise digital control circuit (Yamaha original YAC-520 LSIs) for all channels. The wide control range extends from -80dB to +16.5dB, with narrow 0.5dB steps throughout the entire range for delicate control, even at low volumes.

Triple the Density

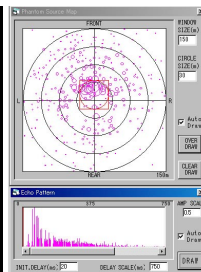
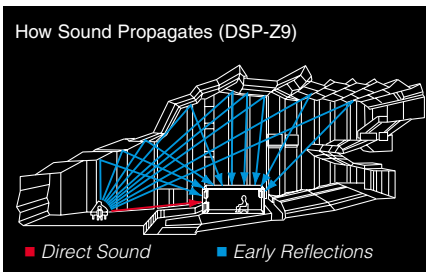
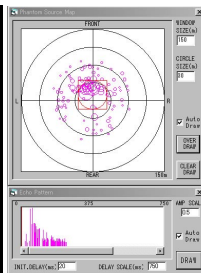
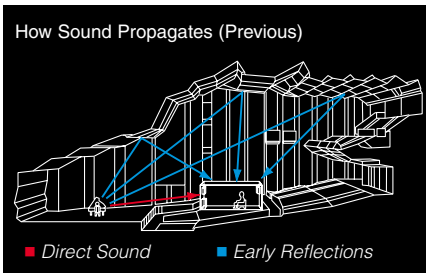

Double the Speed

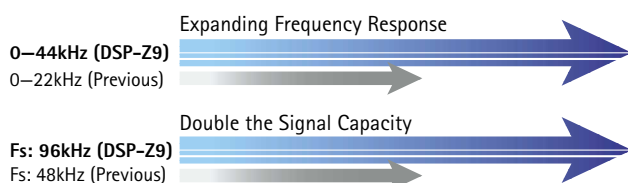

and Virtual CINEMA DSP for two-speaker systems are also included.

Even though CINEMA DSP has been the premier DSP technology in the world for the past few years, Yamaha has upgraded it in the DSP-Z9. In fact, this amplifier has 6 times greater DSP capacity than previous models, thanks to an increase from 48k to 96k signal capability and 3 times higher density early reflections, as shown in the above photos.

4-Layer DSP Processing Board

All of the DSP IC chips and related circuitry are located together on a 4-layer board, which provides a number of advantages. The dimensions are smaller (2/3 previous types), so signal paths are shorter and there is more space for the large power supply components. Digital interference is reduced and impedance is lower as well.

Digital Tone Controls

Digital tone controls are provided for left, right and centre channels, allowing a much greater degree of control over the front sound field.

High Current Amplification Achieves Low Impedance/High



The Importance of High Current

Although power rating is often the first thing people look at in an amplifier, high power output does not necessarily mean good sound. High current level is a much more important factor. Yamaha amplifiers have always had fairly high current levels, but with the DSP-Z9, we have further improved this performance.

What It Does

In brief, Yamaha High Current Amplification achieves low impedance, high current power from input (power supply circuit) to output (speaker terminals). This drives the speakers much more smoothly and dynamically, for better sound from all sources, including 2-channel audio.

Specific Improvements

The first problem to be overcome was

the difference in voltage that ordinary amplifiers suffer between the power supply and amplifier circuits, caused by current fluctuations. This was solved by using custom-made, high-grade block electrolytic capacitors and a copper grip for one-point grounding. Another current drop is generally seen between the amplifier circuit and the speaker terminals, caused by the cables, speaker output relays, copper circuit boards, and so on. To increase current here, we used an extra-large, low-impedance transformer and gold-plated speaker relay contacts.

9-Channel High Power, Discrete Amplifier Configuration

The DSP-Z9 delivers a huge 300W to each of seven channels (two front, one centre, two surround and two surround back), as well as 90W to the two

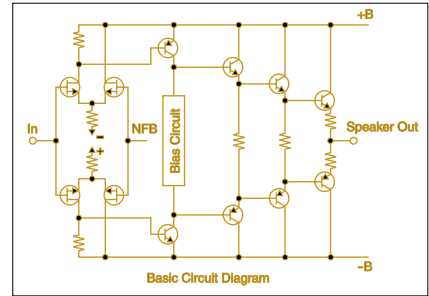

Symmetrical power amplifier circuit configuration results in improved slew rate and balanced clipping.

presence (front effect) channels (DIN). This is more than enough to fill even the largest rooms with vibrant music and dynamic sound effects. 6-4 mixdown is also provided, for enjoying 6-channel input sources from four or five speakers you already have on hand with or without subwoofer. And also The high current amplification system uses symmetrical drive and a full push-pull circuit configuration with a complementary FET input stage. A large toroidal transformer and large capacity block chemical condenser (28,000µF) ensure a stable power supply.

High Current Amplification Principle

The voltage (A) of Block Electrolytic Capacitors and voltage (B) of Power Transistor Collector should be ideally at the same level. However, when the current become large, there will be a big difference in the level of each voltages.

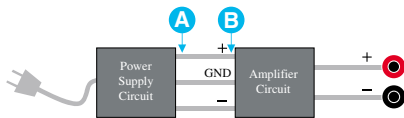

Voltage level difference between A (power supply circuit) and B (amplifier circuit).

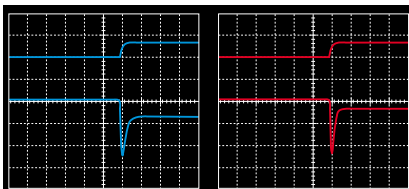

Conventional Amplifier

High Current Amplification

There is also a level difference between Output of the Power Amplifier (C) and Speaker Terminals (D), which is reflected by coppers of PCB, Speaker output relays, cables and so on, resulting in damaging the sound quality.

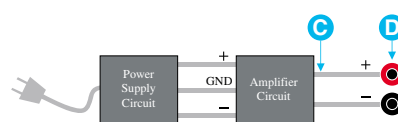

Voltage level difference between C (amplifier circuit output) and D (speaker terminals).

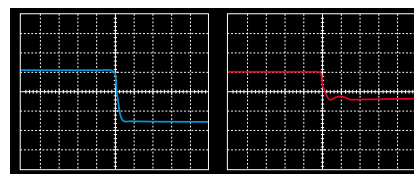

Conventional Amplifier

High Current Amplification

High Dynamic Power Capability

The DSP-Z9 is capable of delivering large amounts of reserve power for accurate reproduction of the high energy peaks that are especially prevalent in digital audio sources. This emphasizes the music's dynamic qualities and provides a sharper sound image.

Linear Damping

Level variations due to high amp impedance tend to reduce an amplifier's damping factor, and frequency variations cause it to fluctuate. This circuit cancels the effect of these variations, maintaining a high, stable

Current Power from Input to Output.

damping factor, for superior articulation of all sounds and better frequency response.

Super High Grade Construction and Finest Parts Used Throughout

The DSP-Z9 uses a heavy-duty, rigid chassis construction with separate chambers for individual sections to prevent any internal interference. The chassis also has electromagnetic shielding. Large, anti-resonance, aluminium-extruded heat sinks provide effective heat dissipation. Supporting all this is Yamaha's ToP-ART base and ART (anti-resonance and tough) feet, which provide stability and complete vibration-damping. The speaker terminals are gold-plated, super-quality, 2-way binding post types.

In order to realize the goals of massive power and superlative sound quality, Yamaha technicians completely

re-evaluated all the parts used in previous amplifiers. As a result, many were replaced with more expensive or custom-designed units.

- Two Direct Signal Path Speaker Relays with Gold-Plated Crossover Connection and Shielding
- Thick PC Board Wiring with 1.6mm ϕ Copper Jumper Cables
- High Sound Quality Schottky Barrier Diode for High Gain S/N Ratio
- Extra-Thick (100mm) Aluminium-Extruded Front Panel
- Discrete Power Supply Configuration for All Channels

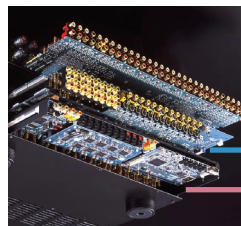

3-Layer Construction

Gold-Plated-Extruded Gigantic Speaker Terminals

Power Amplifier (Left) with Large, Anti-Resonance, Aluminium-Extruded Heat Sink (Left) Providing Effective Heat Dissipation

Control Section

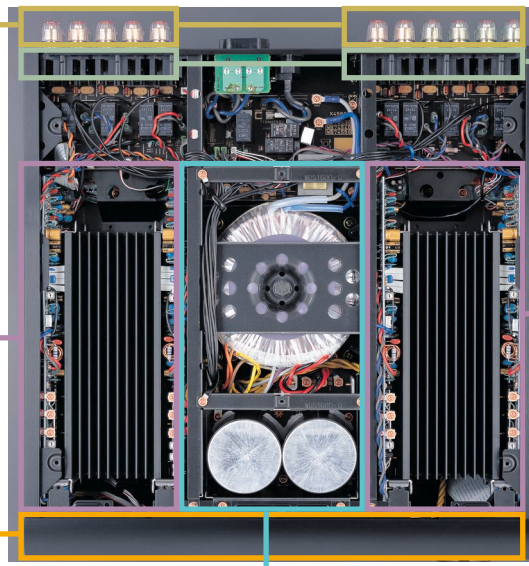

Two Direct Signal Path Speaker Relays with Gold-Plated Crossover Connection and Shielding
Power Amplifier (Right) with Large, Anti-Resonance, Aluminium-Extruded Heat Sink (Right) Providing Effective Heat Dissipation

Power Supply Chamber with Extra-Large Toroidal Transformer and Extra-Large Custom-Made Block Electrolytic Capacitors (28,000 μ F)

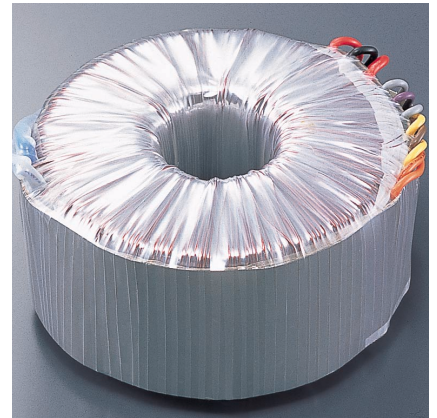

Extra-Large Toroidal Transformer



Extra-Large Custom-Made Block Electrolytic Capacitors (28,000 μ F)



Gold-Plated-Extruded Gigantic Speaker Terminals

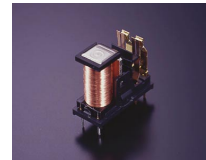

Two Direct Signal Path Speaker Relays

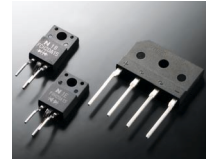

High Sound Quality Schottky Barrier Diode for High Gain S/N Ratio



Selected High Quality Parts

Yamaha CINEMA DSP for Home Cinema: Dramatically Different

Going Beyond Conventional Multi-Channel Systems



Conventional multi-channel audio reproduction systems base their sound on Dolby Digital and DTS decoding, using matrix and steering technologies to create surround sound effects. Yamaha CINEMA DSP is much more advanced, actually creating richly realized independent sound fields that merge to envelop you in an unmatched surround sound experience. With dialogue, music and effects from the presence (front line), surround and surround back fields, you will hear sound with highly

accurate localization, smooth movement, exceptional clarity and richness, and startlingly realistic presence. It will seem as if the walls of your room have disappeared and you are in the middle of your own immense theatre!

Quad-Field and Tri-Field CINEMA DSP

Tri-Field CINEMA DSP projects three sound fields into the home cinema: a Presence sound field in the front and two Surround sound fields in the left rear and right rear, resulting in a powerfully realistic three-dimensional soundscape. And now Yamaha also offers Quad-Field CINEMA DSP. It adds an additional surround back sound field to the Tri-Field system, in

order to enjoy the 6.1-channel formats, Dolby Digital EX and DTS-ES.

CINEMA DSP Programmes and THX Programmes

One of the main advantages of CINEMA DSP is the large choice of sound field programmes available. The basic programme for movies is Enhanced, which greatly improves the sound of the surround fields. The "largest" of these sound fields is Spectacle, which recreates the open feeling of large-scale, epic motion pictures. The Sci-Fi, Adventure and General programmes provide the optimum sound fields for those movie genres. There are also six THX programmes, including Ultra2*.

* THX Ultra2 is a surround programme for home use, based on the THX Theater processing developed for movie theater surround sound.

DSP-Z9 Surround Programmes: 55 Surround Programmes (79 Variations)

STEREO	● 2-Channel Stereo	
	● Direct Stereo	
HIFI DSP Programmes		Variations
	● Munich A	1
	● Frankfurt	1
CONCERT HALL 1	● Stuttgart	1
	● Munich B	1
	● Vienna	1
CONCERT HALL 2	● Amsterdam	1
	● Hall G in U.S.A.	1
	● Hall H in U.S.A.	1
	● Live Concert	1
CHURCH	● Tokyo	1
	● Freiburg	1
	● Royaumont	1
JAZZ CLUB	● Village Gate	1
	● Village Vanguard	1
	● The Bottom Line	1
ROCK CONCERT	● The Roxy Theatre	1
	● Warehouse Loft	1
ENTERTAINMENT	● Arena	1
	● Disco	1
9-CH STEREO	● Party	1
	● 9-Channel Stereo	1
Programme Subtotal	21	21

CINEMA DSP Programmes	Variations
● Game	1
● TV Sports	1
● Mono Movie	1
● Pop/Rock	1
● DJ	1
● Classical/Opera	1
● Pavilion	1
● Spectacle	5
● Sci-Fi	5
● Adventure	5
● General	5
● Enhanced	5
Programme Subtotal	32

Remarks

- : HiFi DSP Programmes
- : A/V Programmes
- : CINEMA DSP
- : Tri-Field CINEMA DSP Capable
- : Quad-Field CINEMA DSP Capable
- **All DSP programmes are available in the SILENT CINEMA and Virtual CINEMA DSP modes.**

Decoder Straight Programmes	Variations
● Dolby Digital	1
● Dolby Digital/ EX	1
● DTS Digital Surround	1
● DTS 96/24	1
● DTS-ES Matrix 6.1	1
● DTS 96/24 ES (6.1)	1
● DTS-ES Discrete 6.1	1
● Dolby Pro Logic	1
● Dolby Pro Logic II Music	1
● Dolby Pro Logic II Movie	1
● Dolby Pro Logic II Game	1
● Dolby Pro Logic IIx Music	3*
● Dolby Pro Logic IIx Movie	3*
● Dolby Pro Logic IIx Game	1
● DTS Neo:6 Music	1
● DTS Neo:6 Cinema	1
Programme Subtotal	20

THX	Variations
● Cinema	1
● Ultra 2 (5(3).1 & SB x 2)	1
● Music	1
● ES Matrix 6.1	1
● ES Discrete 6.1	1
● Surround EX (6.1 or Forced On)	1
Programme Subtotal	6

Programme Total	55	79
------------------------	-----------	-----------

*Only when using Surround Back x 2 Speakers for normal, Dolby Digital and DTS.

Auto Priority Input Terminal Selection and Auto Decoder Selection

Digital input terminals are provided to handle any kind of digital input. Functions are programmed to select priority in order of coaxial digital, optical digital and analogue when different digital formats are

input from the same source. The sound decoder is also automatically selected and processed according to the combination of the format of input signals and the selected sound field programmes, while DSP sound field processing is optimized at the same time.

Than Other Systems.

Night Listening Mode for All Surround Programmes

When you're listening to movies late at night and turn down the volume during loud scenes, dynamic range suffers and you may miss some dialogue and other sounds. By engaging the Night Listening mode, you can reduce the volume and still enjoy proper tonal balance and dynamic range. You hear dialogue clearly and the music and action are just as exciting (without the screams and explosions disturbing others).

Audio Delay for Adjusting Lip-Sync

The YSS-930 LSI in the DSP-Z9 provides synchronization of images and sound, which is called lip-sync. Most home theater LSIs do not have

the necessary speed and precision to handle this, but the YSS-930 is able to do it accurately. What's more, by using the Audio Delay mode, lip-sync parameters can be adjusted whenever necessary.

SILENT CINEMA and Virtual CINEMA DSP

SILENT[™] CINEMA

The SILENT CINEMA mode gives you private listening enjoyment of multi-channel music or movie sound, including Dolby Digital and DTS surround, through ordinary headphones. It's automatically selected when the headphones are

plugged in. Virtual CINEMA DSP lets you enjoy the effects of CINEMA DSP surround sound without using surround speakers (handy for use in custom installations where some rooms don't have surround speakers). It can be used with the front/centre/presence speakers or even with just the two front left and right speakers.



SILENT CINEMA Sound Field Imaging

Quad-Field CINEMA DSP

Conventional 7.1-Channel Systems



Surround Left
Sound Field

Presence (Front Line) Sound Field

Effect Music

Dialogue

Surround Back
Sound Field

Surround Right
Sound Field



YPAO (Yamaha Parametric Room Acoustic Optimizer) and Easy

YPAO: The Best Sound for Your Room — Automatically!

This new capability is one of the DSP-Z9's most innovative and appealing features. The amplifier comes supplied with a small microphone, which the user places in the listening position. Activating the functions causes a test tone to be emitted, which is analyzed, and based on the results, the audio output is automatically adjusted to provide the optimum sound for the room acoustics. The optimizer functions as a parametric, not merely a graphic, equalizer, providing a degree of precision calibration that users could not do by themselves. Among the factors considered are speaker connection, speaker size, channel level balance, speaker distance and speaker frequency response. In short, the DSP-Z9 not



DSP-Z9 Optimizer Microphone

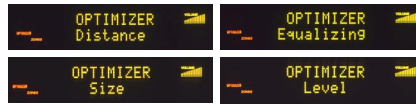

only delivers better sound, it delivers the BEST sound for each and every room.

On-Screen Display with GUI (Graphical User Interface)

A handy GUI that includes extensive yet easily understandable setup menus makes it easy to select and adjust desired functions. Especially useful is a speaker display in the Speaker Test mode that makes it easy to balance the levels of all speakers. DSP programmes can be selected with the remote control so their effects can be judged from the listening position.



Programme Name and Surround Sound Indications

The front panel display shows a variety of surround sound status indications, so you always know what modes you are in. Six sound field modes including Quad-Field and Tri-Field are also indicated.



Yamaha Parametric Room Acoustic Optimizer (YPAO)

1) Speaker Connections
Checks for missing connections and subwoofer phase control (here the right surround speaker is not connected).

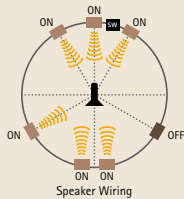

4) Speaker Frequency Response
Measures and optimizes each speaker's frequency response using the 10-band parametric equalizer.

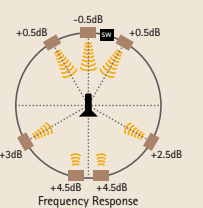

2) Speaker Distance
Measures speaker distances from the listening point and corrects for differences down to 5cm.

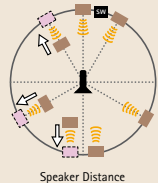

5) Sound Pressure Level
Measures and aligns the sound pressure levels of all speakers.

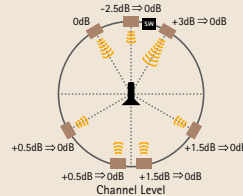

3) Speaker Size
Checks speaker sizes (large or small) and subwoofer crossover frequency.

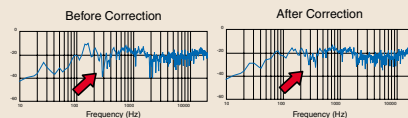
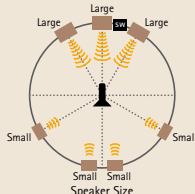

Graphic Equalizer vs. Parametric Equalizer



Conventional Graphic Equalizer



Yamaha Parametric Equalizer

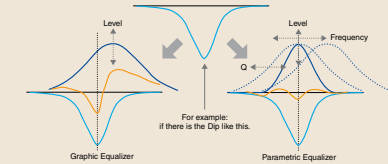

YPAO
YPAO provides frequency response compensation of all channels via a 10-band parametric equalizer. Graphic equalizers adjust only the level, while parametric equalizers adjust level, frequency and Q factor, thus providing more detailed and effective sound equalization.

Setup Operation

Easy Setup and Operation

The RX-Z9 has an ergonomic design that ensures simple, convenient operation. Everything from the layout of the controls to the appearance and selection of the operating menus has been planned to make using it easy and enjoyable.

Wide Range of Detailed Menus

The remote control lets you access and adjust a wide range of menus on the on-screen display, for total operational control. You can use the Auto Setup menu to select which speaker parameters will be automatically adjusted, or you can adjust speaker and system parameters yourself via Manual Setup, which includes four menus.

Basic for setting speaker and subwoofer parameters, Sound for adjusting Cinema EQ, Graphic EQ and other audio functions, Video for selecting Picture Mode, Resolution and five other settings, and Option for Multi-Zone and other functions. There are also Input Select, i.LINK Select, Stereo/Surround, Memory Guard and Signal Info menus.



Cinema and Graphic Equalizers

The Cinema EQ menu allows you to adjust parametric EQ and high fre-

quency levels. You can set frequencies between 1.0 and 12.7kHz, and levels between -9 and +3dB for Front & Center, Surround, Surround Back and Presence speakers. There is also a 9-band graphic equalizer.

Ideal for Use in Custom Installations

The DSP-Z9 has numerous features designed to facilitate use in custom, multi-room installations. These include Zone 2 coaxial digital, video (inc. S-Video) and audio output for multi-room control capability, speaker A/B selection, an RS-232C interface with extended IR code for two-way communication, two trigger outputs and two IR ports.

A/V Rec Out Selector with Zone 2 Selector

The Rec Out Selector lets you choose which source you want to record. As you are recording, you can listen to that source or to the source selected by the Input Selector. The Rec Out Selector also functions as a Zone 2 Selector.

Subwoofer Crossover Selection

The DSP-Z9 provides a choice of nine subwoofer crossover frequencies: 40, 60, 80, 90, 100, 110, 120, 160 and 200 Hz. In addition to providing a wider range than other amplifiers, the steps from 80 to 120 Hz are only 10 Hz apart for more precise selection. This choice of crossovers lets you “fine-tune” the audio system by selecting the optimum frequency to maximize amplifier/speaker efficiency and also ensures best performance from a wider variety of speakers (small to large).

Dialogue Lift

When using a center speaker positioned below the screen, dialogue may not be heard with maximum clarity. The Dialogue Lift function causes part of the center channel sound to be output from the left and right front speakers, so you hear the dialogue more clearly.

Inlet-Type Power Cable

The Inlet-Type Power Cable is separate, rather than attached to the unit. It is a thicker type than usual, for higher power handling capacity.

Direct Access Remote Unit

The remote control can “learn” the functions of other components, so you can use it as a single remote for the entire system. The buttons in the component control area have different functions for each type of component, selected by pressing the input button. The input name is shown in the LCD window, and you can change each name. Frequently used functions are easily accessible on the front, while others are located under the sliding panel.

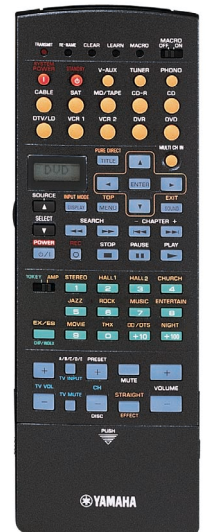

Other Notable Features

- Large Rotary Encoder Input Selector
- Level Setting for Each input
- Sleep Timer

Sophisticated Video Technology and Complete Digital Video Conversion

Digital Component Video Up-Conversion

One way of ensuring the highest video quality for your home cinema system is to use the best possible video signal. The DSP-Z9 automatically upgrades the input signal (composite to S-Video or component, S-Video to component) to the one that your monitor/TV can accept. Not only that, but all signals pass through the DCDi and Noise Shaped Video circuits further improving them. This means that you simply use the best possible cable between the amplifier and the monitor/TV, and then whatever the source is, you are assured of getting the highest possible quality.

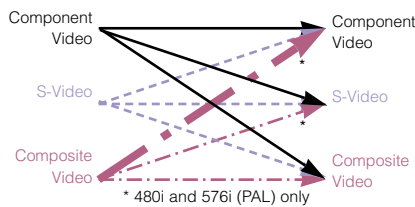

DCDi Processing

DCDi™ by FAROUDJA The DSP-Z9 is the first amplifier to offer Faroudja's DCDi Processing, which is selectable and ensures that images are smooth and natural, without staircasing or jaggies.



Faroudja DCDi LSI (Genesis FLI2310)

Noise Shaped Video™



This technology, from Analog Devices, uses oversampling and advanced techniques such as multi-bit sigma-delta processing and bit-shuffling to improve converter performance by moving converter noise to an area of the spectrum where it can be removed by an analogue filter. This improves the accuracy of signal representation, allowing images to be displayed at much higher resolutions.

Progressive Scan Video Output and Other Video Technologies

The DSP-Z9 is the first amplifier to provide Progressive Scan Video Output, for use with high definition monitors. With almost twice as much video data, it provides a sharper, noise-free picture with clearer details. The progressive circuit is an Area Adaptive 3:2 Pull-Down Detection type, and gives you the benefit of progressive scanning even if your DVD player does not have it. Other video technologies include 216MHz/12-bit Video D/A Conversion, Motion Adaptive Noise Reduction, Cross Color Suppression, Aspect Ratio Conversion, a Time Base Corrector that prevents the wavy distortion seen in video

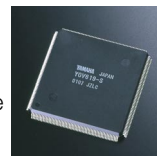

YGV-619 Yamaha Original LSI

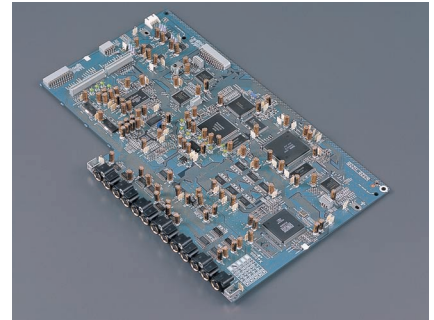

Digital Video Processing Board

All digital video processing circuitry is on a single board, housed in its own separate chamber to completely avoid interference from other circuitry.

tapes and TrueLife Enhancer by Farouja that brings out details in the picture, producing a more life-like image.

Image Adjustment

To ensure that the high quality image looks precisely the way you want it to, the DSP-Z9 includes an extremely detailed Image Adjustment function. You can select three modes, Cinema, Standard or Dynamic, and within those modes, you can "fine-tune" five parameters: Enhancer, 3D NR, Brightness, Contrast and Saturation. You can then store your final adjustments in the user memory for recall at any time.

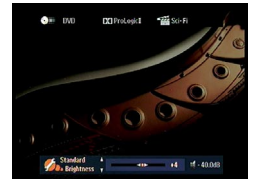

Before TrueLife Enhancer (Left) vs. After TrueLife Enhancer (Right)

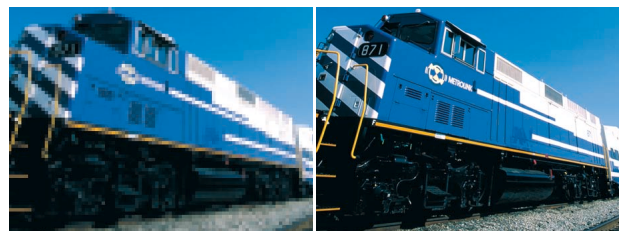

DCDi Off (Left) vs. DCDi On (Right)



Without Film Mode (Left) vs. With Film Mode (Right)



Time Base Corrector Off vs. Time Base Corrector On (Right)

Versatile, Extensive Connections



Oil-Damped Hidden Control Panel

Front Panel Aux Input Terminals with Optical Digital and S-Video Terminals: Auxiliary terminals with optical digital input make it convenient to connect a digital game machine so you can enjoy DVD games and movies.

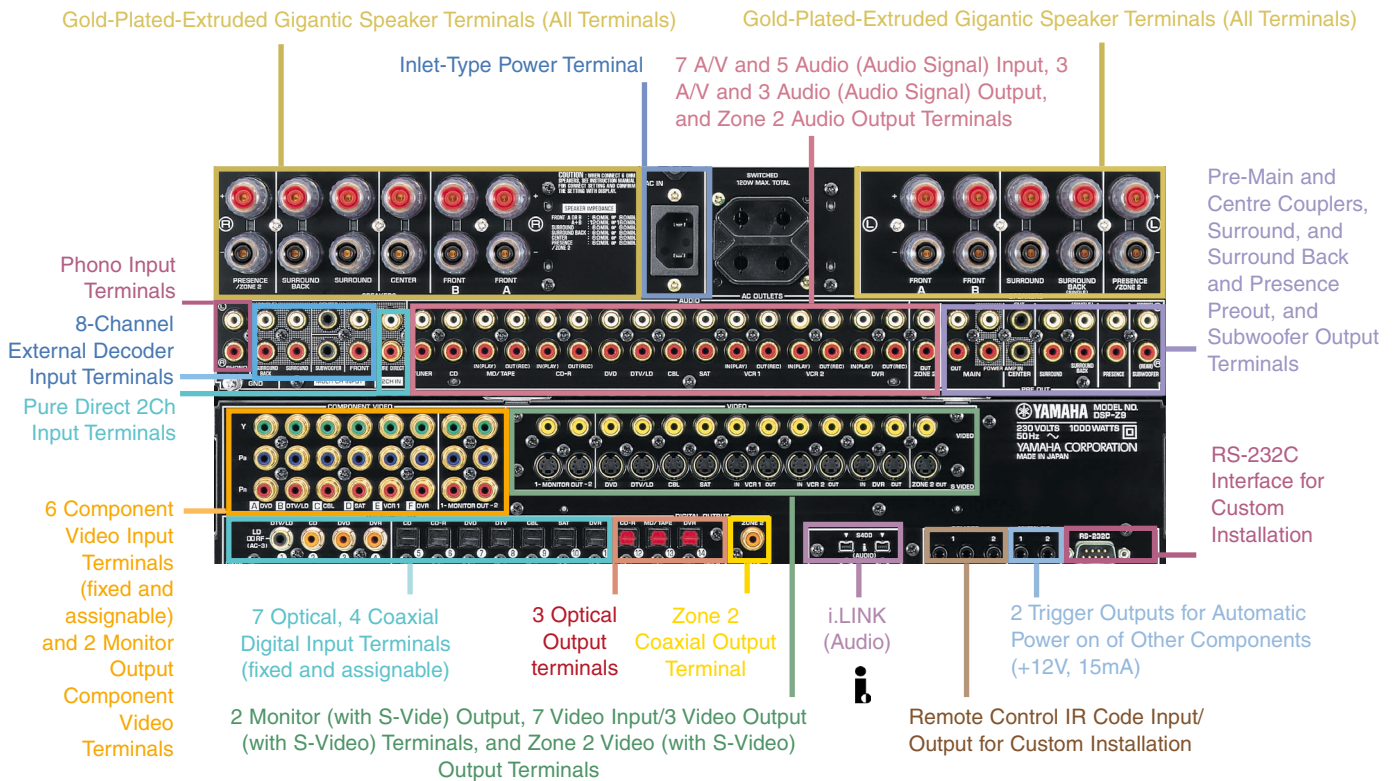

DSP-Z9 Inputs and Outputs

	Analogue		Digital				Video					
	In	Out	Coaxial		Optical		Composite		S Video		Component Video	
	In	Out	In	Out	In	Out	In	Out	In	Out	In	Out
PHONO	■											
CD	■		■		■							
TUNER	■		■		■							
MD/TAPE	■	■	■		■		■	■				
CD-R	■		■		■		■	■				
DVD	■		■		■				■		■	
DTV/LD	■		■	●	■							
CBL	■		■		■						■	
SAT	■		■		■						■	
VCR 1	■	■	■		■						■	
VCR 2	■		■		■						■	
DVR	■	■	■		■						■	
Video Aux	■				■				■			
Monitor Out 1												■*
Monitor Out 2												■*
ZONE 2				■								
Multi-Ch	■											
Pure Direct 2-Ch	■											

Fixed (■), Fixed/Assignable (■) and Assignable (●) Terminals.
RF (AC-3) terminal for LD input (●) is assignable as coaxial digital terminal.

Fixed and Assignable Terminals

Yamaha offers terminals that can be either independently assigned to sources or defaulted to fixed settings.

■*: HDTV (720p/1080i) Compatible Component Video Out

Frequency response of Component Video Monitor Out signal is 5 – 100MHz (processor off), making it compatible with HDTV monitors.

DSP-Z9 Main Specifications

AUDIO SECTION

DIN Standard Output Power (4 ohms, 1 kHz, 0.7% THD)		
Front Channels		300 W + 300 W
Centre Channel		300 W
Surround Channels		300 W + 300 W
Surround Back Channel		300 W + 300 W
Presence Channel		90 W + 90 W
Minimum RMS Output Power (8 ohms, 20–20,000 Hz, 0.015% THD, FTC)		
Front Channels		170 W + 170 W
Centre Channel		170 W
Surround Channels		170 W + 170 W
Surround Back Channel		170 W + 170 W
Presence Channel		50 W + 50 W
High Dynamic Power, Low-Impedance Drive Capability		
	Yes	
Dynamic Power/Channel	8 ohms	210 W
	6 ohms	260 W
	4 ohms	340 W
	2 ohms	580 W
Linear Damping		
	Yes	
Damping Factor (8 ohms, 20–20,000 Hz)		200 (speaker A)
Input Sensitivity/Impedance	Phono (MM)	2.5 mV/47 k-ohms
	CD	200 mV/47 k-ohms
Frequency Response		10–100,000 Hz +0, -3 dB
Total Harmonic Distortion (20–20,000 Hz)		
	CD (Front/Centre In, Sp Out, 85 W/8 ohms)	0.005%
Signal-to-Noise Ratio (CD, 250 mV)		100 dB
Speaker/Headphone Tone Control Characteristics (Front/Centre/Subwoofer)		
Bass	Boost/Cut	+6 dB/-6 dB (50 Hz)
	Turnover Frequency	125 Hz/350 Hz/500 Hz
Treble	Boost/Cut	+6 dB/-6 dB (20 kHz)
	Turnover Frequency	2.5 kHz/3.5 kHz/8 kHz

Manual Graphic Equalizer (Front/Centre/Surround/Surround Back/Presence)		
f=63 Hz, 125 Hz, 250 Hz, 500 Hz, 1 kHz, 2 kHz, 4 kHz, 8 kHz and 16 kHz		
Q=1.2	Step=0.5	+6 dB/-6 dB
YPAO (Yamaha Parametric Room Acoustic Optimizer)		
f=63 Hz — 16 kHz		
+6 dB/-20 dB,		
10 bands in 25 points		
Crossover Frequencies (Subwoofer Out)		
40, 60, 80, 90, 100, 110, 120, 160 and 200 Hz		
Cinema Equalizer		
High Shaving Filter	Frequency	1,000 — 12,700 Hz
	Boost/Cut	+6 dB/-9 dB
Parametric Equalizer	Frequency	1,000 — 12,700 Hz
	Boost/Cut	+6 dB/-9 dB

VIDEO SECTION

Video Signal Level		1 Vp-p/75 ohms
S-Video Signal Level	Y	1 Vp-p/75 ohms
	C	0.286 Vp-p/75 ohms
Component Video Signal Level	Y	1 Vp-p/75 ohms
	Pb/Cb, Pr/Cr	0.7 Vp-p/75 ohms
Signal-to-Noise Ratio		70 dB (processor on)
Monitor Out Frequency Response		
	Composite/S-Video Signal	5 Hz—10MHz -3 dB
	Component Video Signal	5 Hz—100MHz -3 dB

GENERAL

Standby Power Consumption		Less than 1 W
Dimensions	(W x H x D)	435 x 211 x 471 mm
Weight		30 kg

CINEMA DSP Yamaha's unique technology for the creation of sound fields is capable of powerfully reproducing the three-dimensional environment that movie sound engineers aim to convey, in any audio format from monaural to the latest 6.1-channel digital surround. It is compatible with DVD and all other A/V sources.

Yamaha CINEMA DSP technology has received a patent in the U.S. (Patent No. 5,261,005).

"Silent" is a trademark of Yamaha Corporation.

- Dolby, Pro Logic and Double D are trademarks of Dolby Laboratories Corporation.
- DTS is a trademark of DTS Technology LLC.
- THX and the THX logo are registered trademarks of THX Ltd.
- Surround EX is a jointly developed technology of THX and Dolby Laboratories, Inc. and is a trademark of Dolby Laboratories, Inc.
- Burr-Brown products are trademarks of Texas Instruments, Inc.
- "DCDi" is a trademark of Faroudja, a division of Genesis Microchip Inc.
- NSV is a trademark of Analog Device inc
- "i.LINK" and the "i.LINK" logo are trademarks of Sony Corporation
- Product designs and specifications are subject to change without notice.

For details please contact:

Visit us at our website:
<http://www.yamaha-audio.co.uk>



CREATING 'KANDO' TOGETHER

YAMAHA ELECTRONICS UK LTD
 200 Rickmansworth Rd, Watford, HERTS, WD18 7GQ

PI0001895G-DSPZ9@908